

# Panasonic

ideas for life

Programmable Controller

# FP-X

Advanced Compact Model  
with High Speed, Large Capacity  
and Multi-functions



# X

FP-X Programmable Controller  
ARCT1B255E '05. 5

**NEW**

<http://www.nais-e.com/plc/>  
Panasonic...the new name for **NAIS**

Matsushita Electric Works, Ltd.

# Creating New PLC Standards

## FP-X Meets a Variety of Requirements

Capacity, processing speed, security and expandability

A compact general-purpose PLC was created for meeting the needs of small-scale equipment control by responding to user feedback.

FP-X solves the needs rapidly and reliably with its high performance.

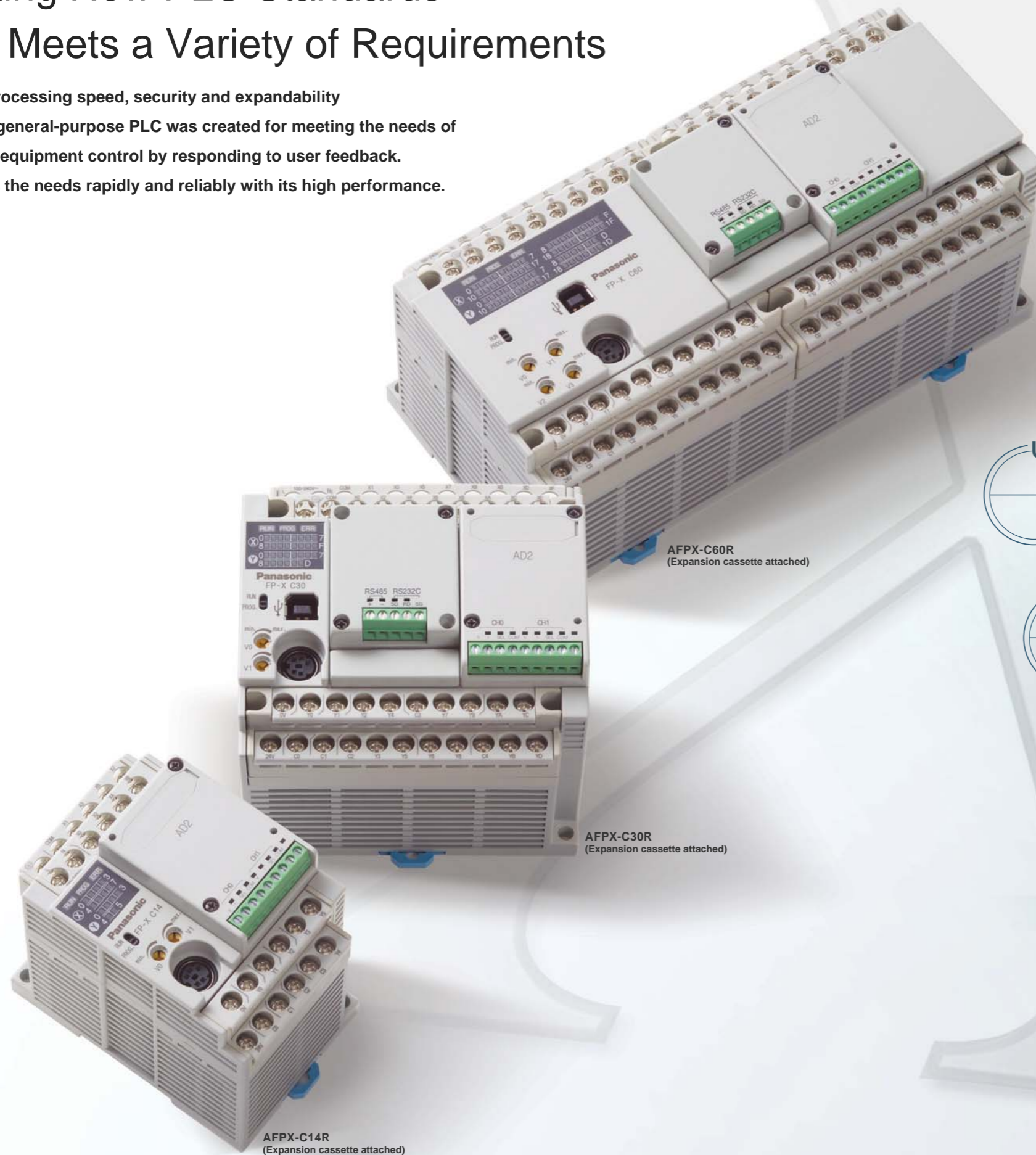

AFPX-C60R  
(Expansion cassette attached)

AFPX-C30R  
(Expansion cassette attached)

AFPX-C14R  
(Expansion cassette attached)

### Ultra High-speed Processing

High-speed scan of 0.32  $\mu$ s for a basic instruction (1.9 ms scan time for 5 ksteps\*<sup>1</sup>)

The processing speed of 0.32  $\mu$ sec, sufficient for a compact PLC, is even applicable when high-speed scanning is required.

\*1: A 5-kstep program consisting of 35% basic instructions and 65% applied instructions (data transfer, four operations)

### Large Capacity with an Extra Margin

Program capacity of 32 ksteps with a sufficient comment area\*<sup>2</sup>

The program capacity of 32 ksteps, exceeding the capacity of most compact PLCs, can flexibly handle a wide variety of applications requiring future equipment expansion.

\*2: C14R: 16 ksteps, C30R-C60R: 32 ksteps

### Great Expandability with a Wide Variety of Options

Max. I/O expansion of 300 points\*<sup>3</sup> and further expansion with a function expansion cassette

The expansion cassette easily enables functional enhancements when slightly more features are to be added, while keeping costs down. The expansion FP0 adapter enables the connection of 3 additional FP0 expansion units. \*3: When the expansion unit E30R becomes available.

**High Security** Program protection with an 8-digit password and a function prohibiting uploads

**USB-port Equipped\*<sup>4</sup>** Easy direct connection with a PC via a commercial USB cable (AB type)













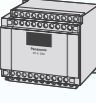

\*4: Not provided with C14R.

Programmable **FP-X**  
Controllers

# The Highly Expandable Lineup Satisfies All Kinds of Needs.

The flexible product lineup designed for rapidly responding to user needs provides a high level of satisfaction.

## Product Lineup

Control Unit		
	<b>AFPX-C14R</b>	Power supply (100 to 240 V AC) DC input: 8 (24 V DC) Relay output: 6 (250 V AC/2 A) Program capacity: 16 ksteps Potentiometer: 2
	<b>AFPX-C30R</b>	Power supply (100 to 240 V AC) DC input: 16 (24 V DC) Relay output: 14 (250 V AC/2 A) Program capacity: 32 ksteps Potentiometer: 2 Equipped with a USB communication port
	<b>AFPX-C60R</b>	Power supply (100 to 240 V AC) DC input: 32 (24 V DC) Relay output: 28 (250 V AC/2 A) Program capacity: 32 ksteps Potentiometer: 4 Equipped with a USB communication port
Expansion Unit		
	<b>AFPX-E16R</b>	DC input: 8 (24 V DC) Relay output: 8 (250 V AC/2 A) Remarks) Two or more E16R can't be connected serially because it can't supply the power to other units.
	<b>AFPX-E30R (Introduced soon)</b>	DC input: 16 (24 V DC) Relay output: 14 (250 V AC/2 A) Remarks) Addition of up to 8 units is possible including E16R and EFP0.
Add-on Cassette (Communication cassette)		
	<b>AFPX-COM1</b>	Communication cassette (RS232C 1 ch.)
	<b>AFPX-COM2</b>	Communication cassette (RS232C 2 ch.)
	<b>AFPX-COM3</b>	Communication cassette (RS485/422 selectable 1 ch.)
	<b>AFPX-COM4</b>	Communication cassette (RS485 1 ch + RS232C 1 ch.)
(Application cassette)		
	<b>AFPX-IN8</b>	Input cassette (24 V DC, 8 input ch.)
	<b>AFPX-TR8</b>	Output cassette (NPN transistor 0.3 A, 8 output ch.)
	<b>AFPX-AD2</b>	Analog input cassette (12-bit non-insulated 0 to 10 V/0 to 20 mA, 2 ch.)
	<b>AFPX-PLS</b>	Pulse I/O cassette (High-speed counter input: single phase 80 kHz 2 ch., 2-phase 30 kHz 1 ch.) (Pulse output: 1 axis 100 kHz < cw/ccw, pulse + sign >)
	<b>AFPX-MRTC</b>	Master memory cassette with a real-time clock (32 ksteps program memory + real-time clock in year/month/day/hour/minute) *Real-time clock needs an option battery.



## Expansion FP0 Adapter



**AFPX-EFP0**  
Up to 3 FP0 expansion units can be connected.

## FP0 Expansion Unit

Part number	Specifications
FP0-E8X	8 ch. DC input, MIL connector
FP0-E16X	16 ch. DC input, MIL connector
FP0-E8YT	8 ch. transistor output, MIL connector
FP0-E8YRS	8 ch. relay output, screw terminal block
FP0-E16T	16 ch. transistor output, MIL connector
FP0-E16P	16 ch. PNP output, MIL connector
FP0-E32T	16 ch. DC input, 16 ch. transistor output, MIL connector
FP0-E32P	16 ch. DC input, 16 ch. PNP output, MIL connector
FP0-E8RS	4 ch. DC input, 4 ch. relay output, screw terminal block
FP0-E16RS	8 ch. DC input, 8 ch. relay output, screw terminal block
FP0-A21	2 ch. analog input, 1 ch. output
FP0-A80	8 ch. analog input
FP0-A04V	4 ch. analog (voltage) output
FP0-A04I	4 ch. analog (current) output
FP0-TC4	4 ch. thermocouple input
FP0-TC8	8 ch. thermocouple input
FP0-IOL	I/O link unit
FP0-CCLS	CC-Link unit
FP0-E32RS*1	16ch DC input, 16ch relay output screw terminal block
FP0-RTD6*1	6ch RTD input
FP0-DPS2*1	PROFIBUS remote I/O unit

\*1 Provided from Panasonic Electric Works Europe AG

## Name and Function of Each Part

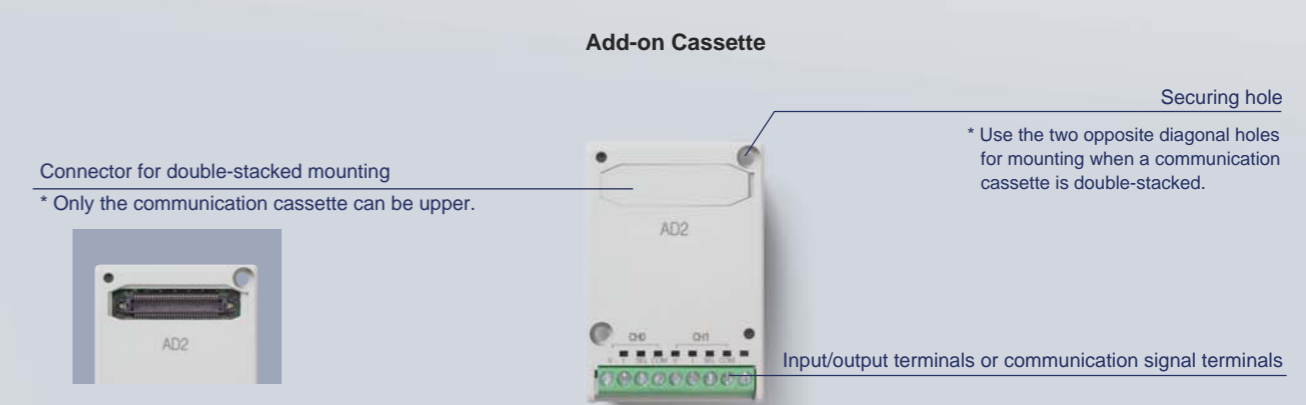
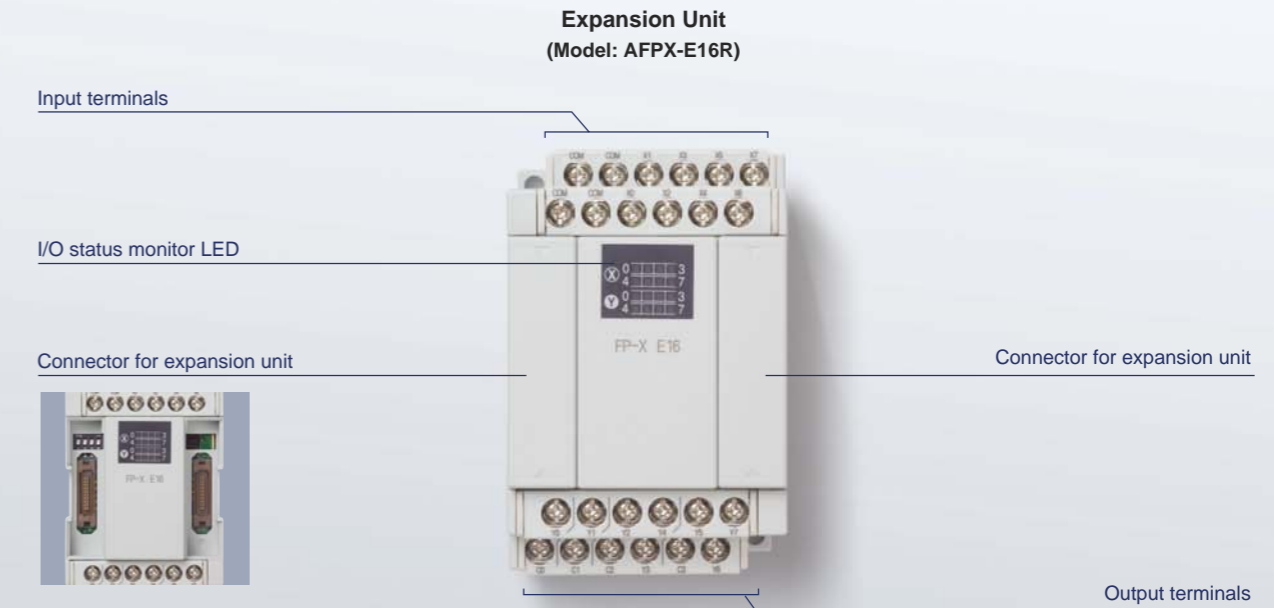
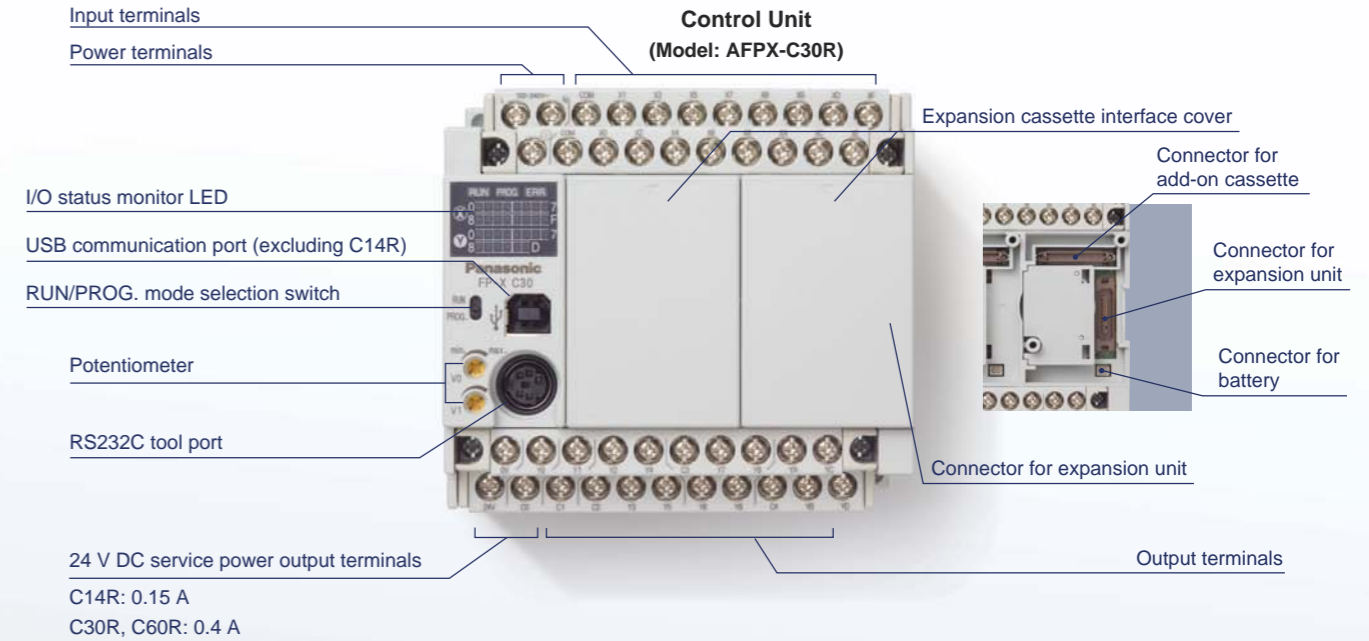

# High Capacity, Ultra High-speed Processing

The high-level basic performance provides sufficient room for future equipment expansion as well as a rich variation.

## ■ Abundant program capacity - 32 ksteps (16 ksteps for C14R)

The program capacity of 32 ksteps, exceeding the capacity of most compact PLCs, can flexibly handle a wide variety of applications requiring future equipment expansion. An adequate comment area has of course been reserved. Free comment entry makes the program easy to understand during verification.

- Separate memory areas reserved for program memory and comments do not cause a reduction of program capacity when comments are entered.
- 100,000 I/O comment items, 5,000 lines of line-space comments, 5,000 lines of remark comments - All comments are stored in the FP-X simultaneously with the program.

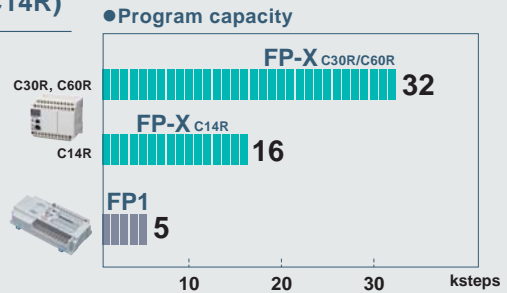

## ■ Ultra high-speed scan at 0.32 μsec for instruction processing

High-speed processing is often required for small-scale equipment control such as serial data communication, network construction or PID temperature control. High-speed scanning at 0.32 μsec/step (basic instruction) easily meets such requirements.

(Ex.) In the case of a 5-kstep program consisting of 35% basic instructions and 65% applied instructions,  
 → Scan time: 1.9 ms (measured time)

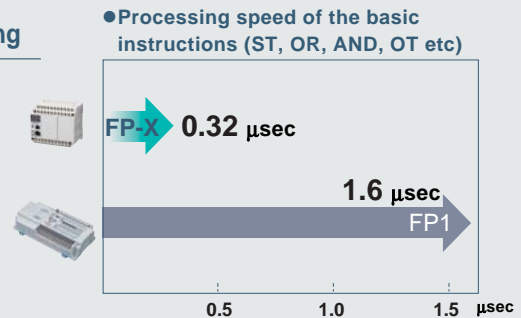

## ■ Abundant number of I/O points - Maximum 300 (Up to 382 points possible by using FP0 expansion units and add-on cassettes)

When the user cannot predict the number of I/O points required in the future for his machine or equipment, he is uncertain in selecting a PLC model. FP-X solves user concerns with a maximum of 300 I/O channels. The number can even be increased up to 382 points by using the add-on cassettes and FP0 expansion units.\*1

- Expansion units (E16R, E30R, EFP0) can be connected up to eight units.

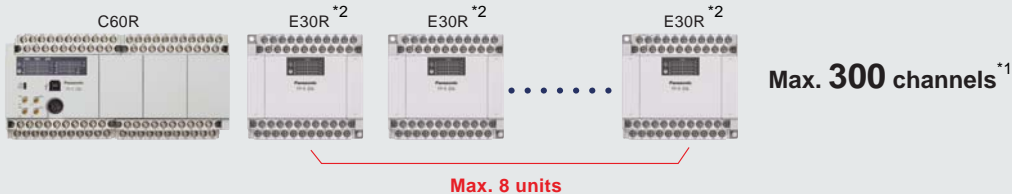

- Two or more E16R can't be connected serially.
- E16R can be sandwiched with E30R\*



- Connection by using the short cable included in each expansion unit.

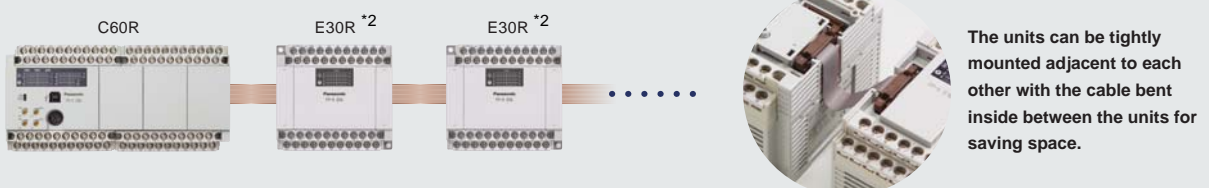

\*1: When E30R becomes available. \*2: E30R available soon

# Great Expandability

"Require slightly more functions", "Want to add functions to the existing equipment"  
- The rich variety of expansion boards helps solve these requirements.

## ■ The Add-on cassette easily adds small quantities of functions and I/O points.

The add-on cassette can be mounted onto the control unit easily.  
Up to 2 cassettes on C14R or up to 3 cassettes on C30R/C60R can be mounted.  
Only communication cassette can be double-stacked upper side. (Communication cassette should be only one totally.)

Note) Please refer to the manual for the number of mountable units and position.

Add-on Cassette		Specifications	
Application Cassette	DC input AFPX-IN8	24 V DC input, 8 ch., bidirectional input (sync/source)	
	Transistor output AFPX-TR8	NPN, 8 ch., 0.3 A	
	Pulse I/O AFPX-PLS	High-speed counter input → Single-phase 2 ch. 80 kHz or two-phase 1 ch. 30 kHz Pulse output → Single-axis 100 kHz (CW/CCW, Pulse+Sign)	
	Analog input AFPX-AD2	2 ch., 12 bits (non-insulated), 2 ms/2 ch. 0 to 10 V or 0 to 20 mA	
	Master memory AFPX-MPTC	32-kstep program storage and transfer Calendar timer	
Communication Cassette	AFPX-COM1	RS232C	1 ch.
	AFPX-COM2	RS232C	2 ch.
	AFPX-COM3	RS485/RS422 selectable <sup>*1</sup>	1 ch.
	AFPX-COM4	RS485 + RS232C <sup>*1</sup>	1 ch. each

\*1: Each of RS485 and RS422 is an insulated type.



Easily removable  
(Two screws to secure the unit)

## ■ When further expansion or functions are required, use the existing FP0 expansion unit.

All control units can be expanded by up to 3 FP0 expansion units via an adapter.  
Applications can be expanded by using [Transistor outputs], [Analog input/outputs], [Thermocouple input] and [I/O link (network)].  
When further expansion or functions are required, use the existing FP0 expansion unit.

\* Only one expansion FP0 adapter unit can be attached to a control unit.  
Up to 7 FP-X expansion units can be used when the expansion FP0 adapter is attached.

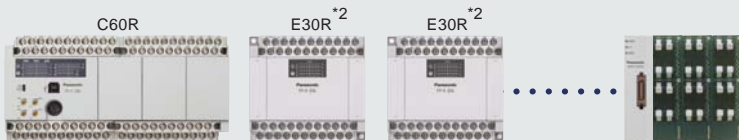

Max. 7 units (210 points)

Max. 96 points



Expansion FP0 adapter

Product number	Specifications	Product number	Specifications
FP0-E8X	8 ch. DC input, MIL connector	FP0-A21	Analog 2 ch. input, 1 ch. output
FP0-E16X	16 ch. DC input, MIL connector	FP0-A80	Analog 8 ch. input
FP0-E8YT	8 ch. transistor output, MIL connector	FP0-A04V	Analog (voltage) 4 ch. output
FP0-E8YRS	8 ch. relay output, screw terminal block	FP0-A04I	Analog (current) 4 ch. output
FP0-E16YT	16 ch. transistor output, MIL connector	FP0-TC4	Thermocouple 4 ch. input
FP0-E32T	16 ch. DC input, 16 ch. transistor output, MIL connector	FP0-TC8	Thermocouple 8 ch. input
FP0-E8RS	4 ch. DC input, 4 ch. relay output, screw terminal block	FP0-IOL	I/O link unit
FP0-E16RS	8 ch. DC input, 8 ch. relay output, screw terminal block	FP0-CCL	CC-link unit
		FP0-E32RS*3	16ch DC input, 16ch relay output screw terminal block
		FP0-RTD6*3	6ch RTD input
		FP0-DPS2*3	PROFIBUS remote I/O unit

\*2: E30R available soon

\*3 Provided from Panasonic Electric Works Europe AG

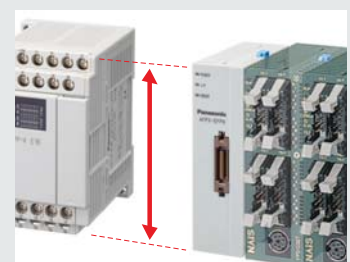

The unified unit height of 90 mm makes the panel surface look clean.

# Reassuring Data Security

## Protects your important program by preventing illegal copies

### ■ Program upload is easily prohibited by tool software FPWIN.

- Once the prohibited status is set with the software tool FPWIN, the reading or copying of programs from the PLC unit becomes completely impossible, thereby protecting user's crucial assets.
- In the upload-prohibited condition, program transfers to the master memory are also prohibited.
- Release of an upload-prohibited condition is possible with a forced release accompanied by a program deletion.
- Program updates are easily carried out by transferring the program in the master memory to FP-X even during an upload-prohibited condition. The transferred program in FP-X is setup with the same upload prohibition and permission conditions used in the master memory.

### ■ More secure eight-character password can be used along with the previous four-character password.

- The combination of upper and lower case alphanumeric characters produces 218 trillion combinations. In addition, after three consecutive entry failures, a power reset is required for password release. When a simple password is preferred, a four-character password can be used. But 3 consecutive entry errors of a four-character password will lock up the system unless the power is reset.

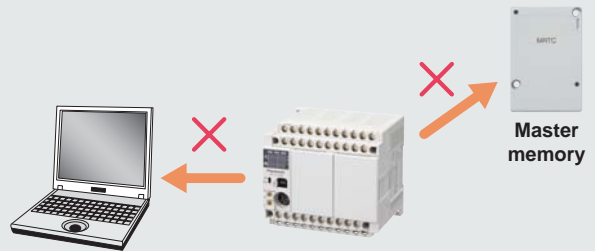

Items possible during an upload-prohibited condition	Items impossible during an upload-prohibited condition
Program download from a PC	Program upload to a PC
Data transfer from the master memory	Data transfer to the master memory
Change of data monitor/resistor value	Password protection
Contact monitor	
Time chart monitor	
Forced input/output (Original program is required)	
Ladder monitor (Original program is required)	
Rewrite during RUN mode (Original program is required)	

# High Adaptability

## A USB port equipped with FP-X enables easy connection with a PC by using a standard USB cable even when the PC does not have an RS232C port. (No USB port with C14R)

### ■ An expensive USB conversion adapter/cable is not necessary for connecting a PC to the PLC by using a standard USB port.\*

- A USB direct connection ensures stable and trouble-free communication by eliminating the conversion adapter and multiple cables.

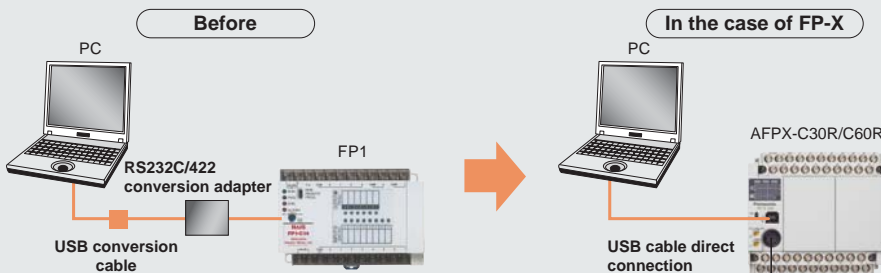

The conventional RS232C port can also be used.

\* USB port is equipped with C30R and C60R.

# Supporting a Variety of Communication Standards

Different types of equipment need to be linked – FP-X flexibly meet such requirements.

## ■ Up to 3 serial communication ports can be used at once.

The use of a communication cassette provides up to 3 serial communication ports.

Usable interfaces include RS232C, RS485, RS422, and USB.

\*The RS232C tool port can be used as a general-purpose serial communication port.

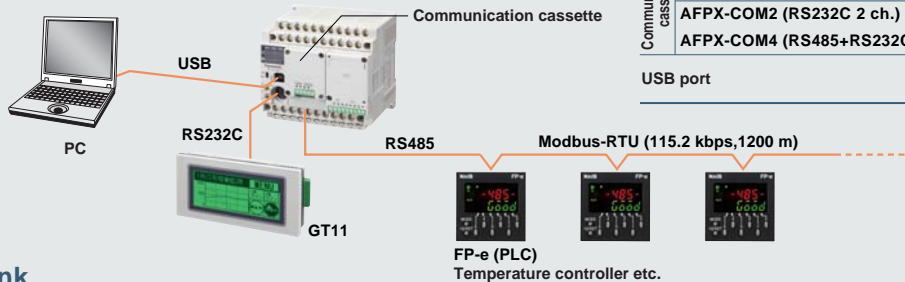

Communication Port			
RS232C tool port		Always used	
Communication cassette	AFPX-COM1 (RS232C 1 ch.)	Always used (Port No. COM1)	
	AFPX-COM3 (RS485/422 selectable 1 ch.)		
	AFPX-COM2 (RS232C 2 ch.)	1st ch.	
	AFPX-COM4 (RS485+RS232C)	2nd ch.	Switch-selectable (Port No. COM2)
USB port		Default setting: USB port use	

## ■ PLC Link

The MEWNET-W0 allows program-free links of up to 16 PLC units such as FP2/2SH or FPΣ. The distributed control system allows efficient model selection.

- Simple setting of the number of linked units, linked relays, and starting area address of the own station by using FPCWIN GR/Pro allows sharing of contact information and data without programming.
- The transfer rate of 115.2 kbps, the highest rate for a compact model.
- A transfer distance of 1200 m, the longest distance for a compact model.
- FP-X and FPΣ allow a change of the station number by programming (SYS instruction).

Item	Specifications
Number of stations	16 stations
Transmission speed	115.2 kbps
Transmission distance	1200 m
Shared data	128 words (data register), 64 words (contacts)
Communication method	Floating master

FP-X requires a communication cassette (AFPX-COM3 or AFPX-COM4)  
 FP2/2SH requires a multi-communication unit (AFP2465)  
 FPΣ requires a communication cassette (AFPG803, AFPG806)



## ■ Modbus Compatibility

Compatible with both the master and slave of the Modbus\* RTU, the world's de-facto standard  
 Great performance is expected for air-conditioning, temperature controls etc.

\* Protocol developed by the Modicon Inc. of the United States

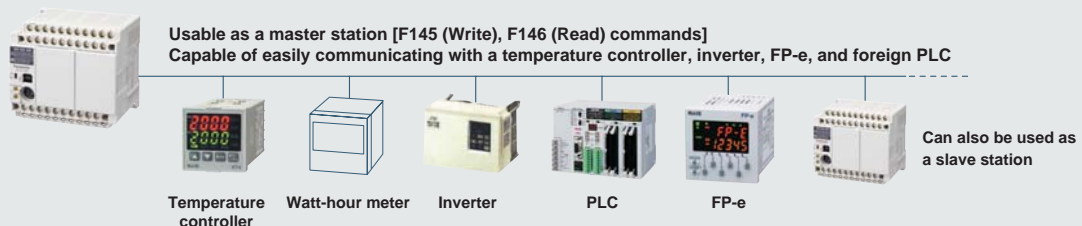

### Another available application

When 17 or more FP-X units need to be linked, the use of a Modbus instead of a MEWNET-W0 can accommodate up to 99 FP-X units. Because each FP-X can be a master or slave, a multi-master link can be constructed by passing a token from a user program.



# Program and Data Maintenance

## Rich functions to support "peace of mind" and "latitude"

### ■ The master memory makes a program transfer easy and a real-time clock is equipped also

- The built-in 1 MB flash-ROM can store a 32-kstep program as well as the comments and FPWIN Pro source file.
- Program update in a remote location is easy by simply sending master memory for local installation.
- Because master memory can store password information, password protection can be applied during a program transfer. Similarly, the upload prohibition/permission function setting can make a program upload-prohibited during a program transfer.
- The built-in real-time clock enables periodical repeated control and periodical data logging.

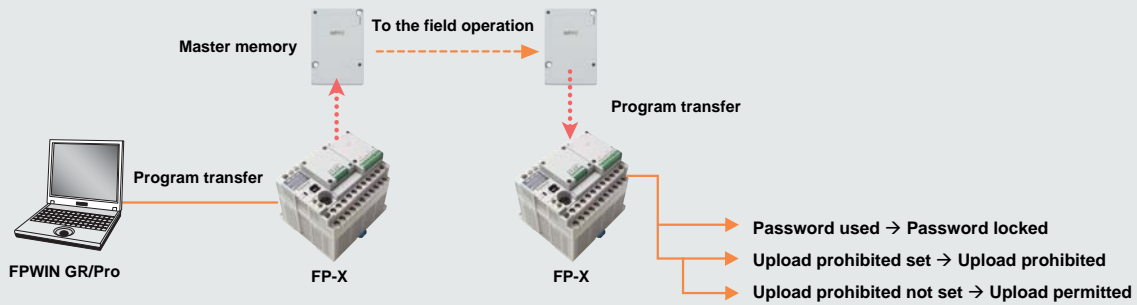

### ■ No need for program backup – easy maintenance

- The programs and comments are stored in flash ROM, requiring no backup batteries.
- A backup battery is provided for data and real-time clock (AFPX-BATT). One battery for C14R, two for C30R and three for C60R can be attached. A two-battery installation can operate for a long time (10 years or more) without maintenance. (Real-time clock doesn't work without a battery.)

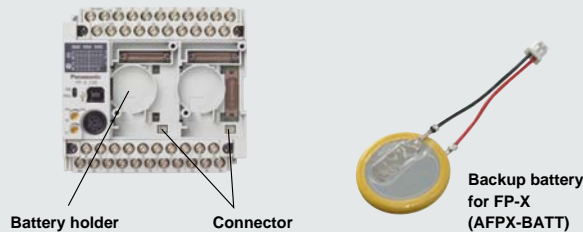

### ■ FROM data storage

- FP-X can store a program, comments, a total of 55 words of data, and bit setting values in a flash memory without a battery. All of the data and bits can be stored by adding optional batteries, but writing into a flash ROM is possible without a battery by using applied instructions (F12, P13). This method is not suitable for a program that is frequently changed because of the limitation in the number of rewrites into the ROM, but good for storing the set values or storing recipe data several times a day.

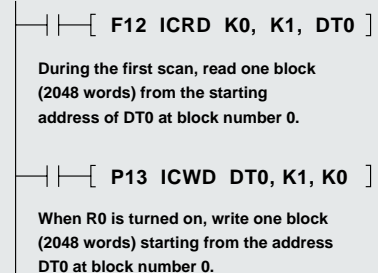

\* The limitation in a flash ROM designates the number of rewrites to be 10,000, or the feasible number to be approx 30,000. However, rewriting every second will generate a memory failure within a few hours.

# High-Speed Counter, Pulse Output

## High-speed counter

- The control unit has eight built-in high-speed counters. Adding two application cassettes (AFPX-PLS) provides four counters, thus taking the total to 12 counters.

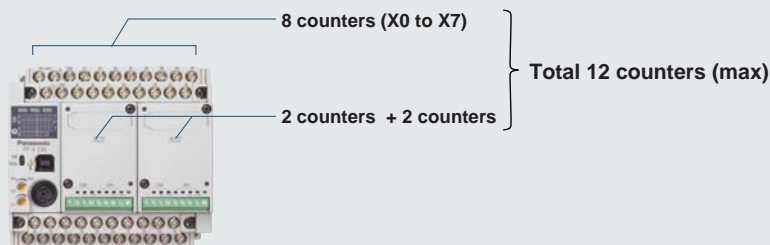

Built-in control unit: Single-phase 8 channels, each 10 kHz, or two-phase 4 channels, each 5 kHz  
 Application cassette (AFPX-PLS): Single-phase 2 channels, each 80 kHz, or two-phase 1 channel, 30 kHz

## Pulse output

- The application cassette (AFPX-PLS) enables 100 kHz motion control. The deviation counter clear signal during an origin return operation is issued in a min of 500 μsec after the origin input and pulse output stopping, thereby causing a minimal position offset required for high-accuracy positioning.

### Linear interpolation

The use of two cassettes provides linear interpolation control with two independent axes, each at 80 kHz speed, enabling pick-and-place and palletizing applications.

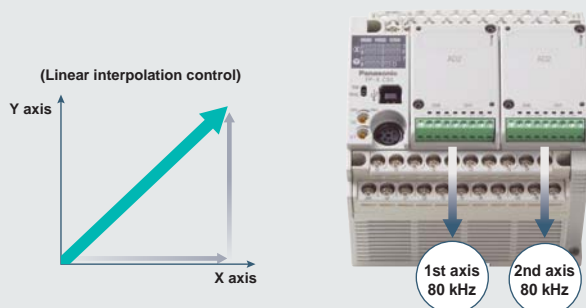

### Also compatible with the CW, CCW method

In addition to the pulse+direction output method, the CW and CCW output method can also be used for high-speed positioning. Either a stepping motor driver or servomotor driver can be selected.

### Simple programming

Programming for a trapezoid operation, jog operations, origin returns, linear interpolations, etc. are easily done. You only have to enter the control operation code, starting speed, target speed, acceleration/deceleration time and transfer distance into the data area and execute a positioning specialty command.

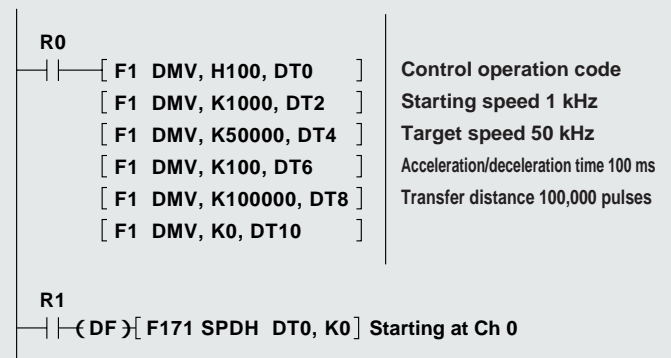

# PID Control

## Multi-point PID control

- High-accuracy PID control is possible by adopting a sophisticated algorithm and floating-point operations.
  - Higher accuracy is obtained by ultra high-speed computations in a 32  $\mu$ s/loop. For example, a 16-loop control only adds a scan time of 0.5 ms by ensuring minimum impact on the tact time.
  - The simultaneous multi-point auto-tuning simplifies complex parameter setting.
  - The high-speed control PI-D\*1 mode and overshoot suppression I-PD\*2 mode are available for selection according to the intended application.
- By combining with a sequence control, the parameters (Kp, Ti, Td, etc.) can be changed during a PID control execution, thereby enabling optimum temperature control in each stage including start up, mid-range, and convergence. The ability to change the target value easily enables multi-step temperature control, which was difficult only with temperature controllers. In addition, the multi-point temperature control enables the centralized control of multiple temperature controllers with a single FP-X for unified data management.

\*1 Derivative type

\*2 Proportional-derivative type

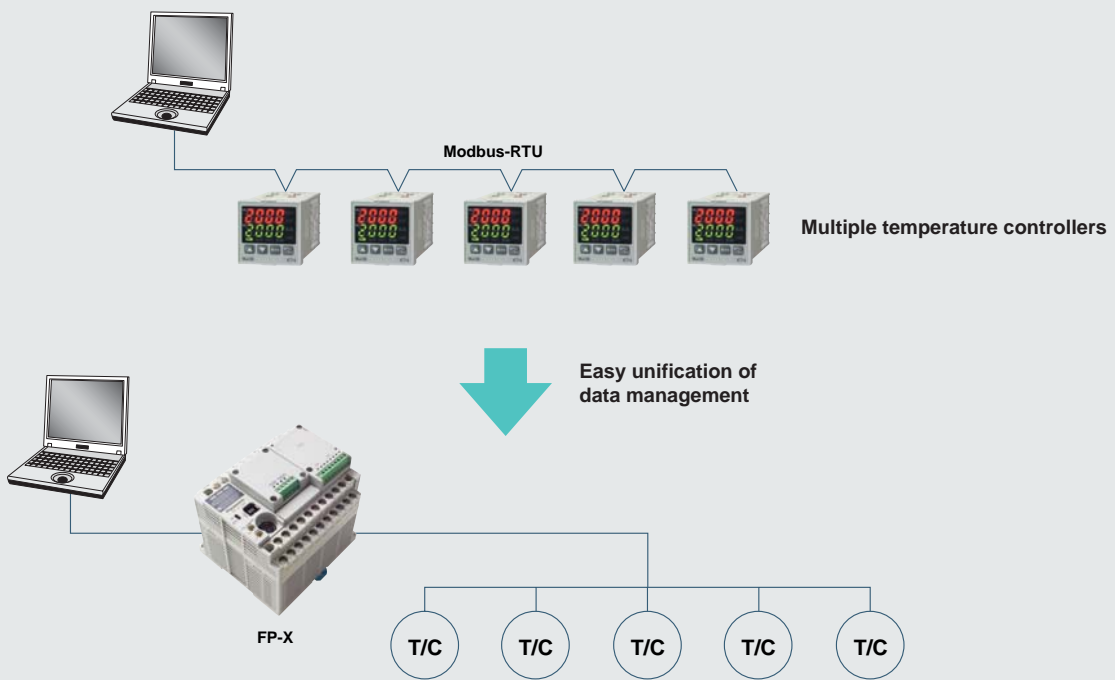

For connecting a thermocouple, please use an FP0 thermocouple unit via an adapter (AFPX-EFP0).

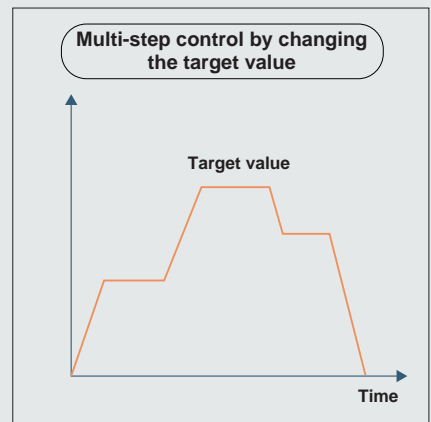
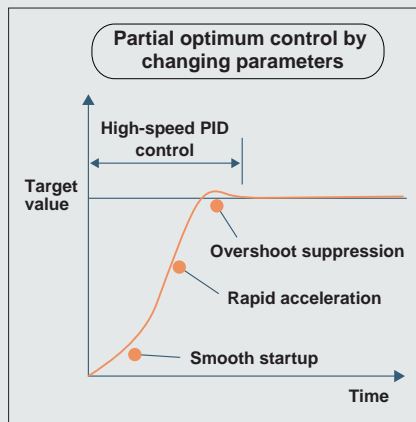
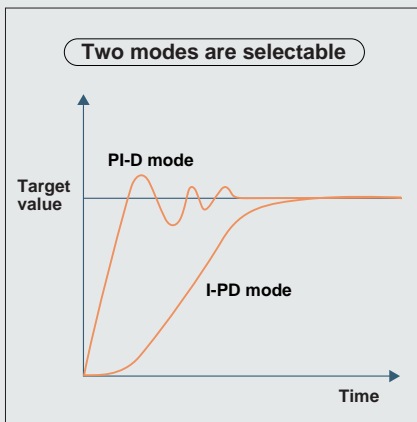

# Simple Program Generation and Monitoring

Note: Product names and company names in this chart are trademarks or registered trademarks of the respective companies.

## Control FPCWIN GR for Windows

The ladder programming software for FP series – highly operational software tool for maximizing convenience in the field.

### ■ Features

1. Easy field operations not requiring the use of a mouse for data entry, search, writing, monitoring and timer changes, all carried out only from the keyboard.
2. Allows standard operations in Windows, such as Copy & Paste, etc.
3. All FP series PLCs are supported. The software assets produced by using Ver. 4 or Ver. 3 of NPST-GR are usable.
4. Easy programming with wizard functions.
5. Communication with OPC Server, CommX, GTWIN, PCWAY simultaneously through the same port.

### ■ Operational Environment

OS	Windows95 (OSR2 or higher)/98/Me/NT (Ver. 4.0 or later)/2000/XP
Hard disk capacity	At least 35 MB
CPU	Pentium 100 MHz or higher
Onboard memory	At least 64 MB (depends on OS)
Screen resolution	At least 1024 × 768
Display colors	High color (16-bit or higher)
Applicable PLC	FP-X/FP-e/FP-e/FP0/FPΣ/FP1/FP-M/FP2/FP2SH/FP3/FP10SH

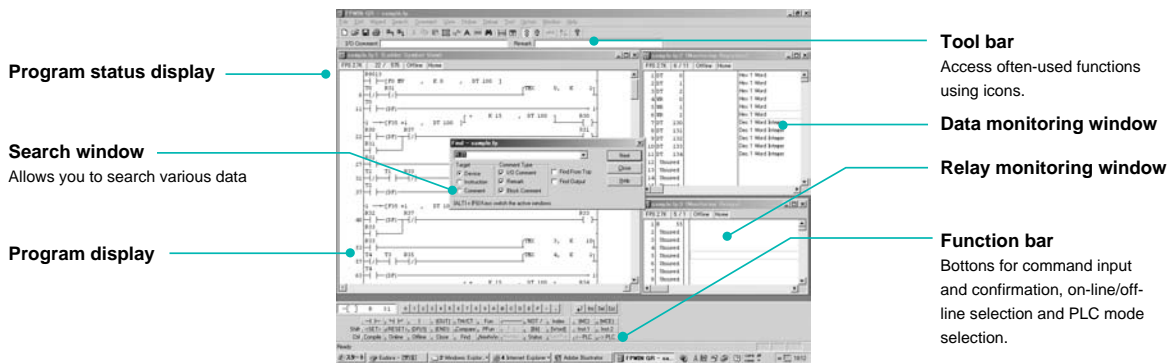

### Function instruction list

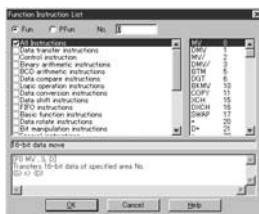

Classified by type, function instructions can be selected from the displayed list. (Simple help included.)

### I/O comment edit function

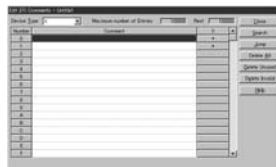

Successive I/O comments can be input for each device type. Data from Excel and other applications can be copied and pasted via the clipboard.

### Status display



Displays information concerning PLC usage situation and settings, and detailed information when an error occurs.

### Text Compiler



This software is for importing and exporting programs created in text format to and from FPCWIN GR. Programs created on the PLC of another company can be edited as text and then be transferred to the FP Series without difficulty.

### Text command input mode

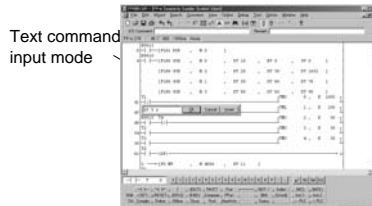

A ladder diagram is displayed as a mnemonic code is entered from the keyboard.

## ■ Accompanying Tools

### ● Data Editor

This software for the PC is for reading and writing data stored in the memory of FP Series main unit or on an IC card. If a large data table is required in a PLC, the data can be created and edited on a PC and then download to the PLC.

### ● Modem connection

Communication via modem is easy with FP Series units in isolated locations.

### ● Wizard function

A Wizard function included in FPCWIN GR since versions 2.2 can automatically generate ladder programs by simply entering and selecting required items in the dedicated screen. It can be used to assist in positioning, PID instruction input, and FP-e screen display instruction input.

### ● Personal preference settings

It is possible to switch among preference settings for FPCWIN GR, Data Editor and Text Compiler that are set up for different individuals.

# Simple Program Generation and Monitoring

FP-X will be supported soon after Ver. 5.1

Note: Product names and company names in this chart are trademarks or registered trademarks of the respective companies.

## Control FPWIN Pro (IEC61131-3 compliant Windows version software)

Compliant with international standard IEC61131-3  
Programming software approved by PLC Open

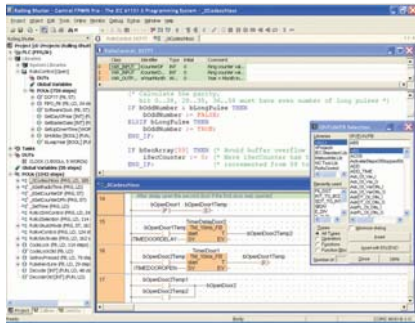
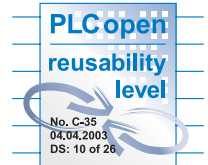

### ■ Features

#### 1. Five programming languages can be used.

Programming can be done using the language most familiar to the developer or using the language most suited to the process to be performed. High-level (structured text) languages that allow structuring, such as C, are supported.

#### 2. Easy to reuse well-proven programs

Efficiency when writing programs has been greatly increased by being able to split programming up for each function and process using structured programming.

#### 3. Keep know-how from getting out

By "black boxing" a part of a program, you can prevent know-how from leaking out and improve the program's maintainability.

#### 4. Conversion function for previously written programs provided to allow use of program assets.

#### 5. Uploading of source programs from PLC possible.

Maintainability increased by being able to load programs and comments from the PLC.

\* This only applies to FP-X, FPΣ and FP2 (with comment memory) and to FP2SH and FP10SH (with card board).

#### 6. Programming for all models in the FP series possible.

Any model can be used.

### ■ Programming in the most suitable language

#### ● Programming in the language most suited to the process

Easy-to-understand, efficient programs can be created, for example, by using a ladder program for machine control or ST for communications control.

#### ● Programming in the language you are good at

Programming time can be greatly reduced by the easy ability to split and then integrate programming for each function and process.

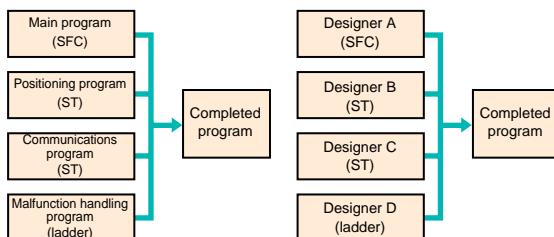

### ■ "Black boxing" of programs

#### ● Multiple passwords for protection of each block

The security level (8 levels) can be input for each block in a program. Only users of a set security level or higher can make changes.

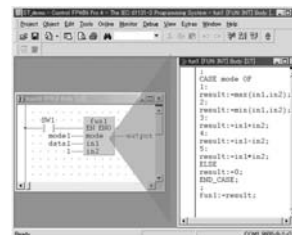
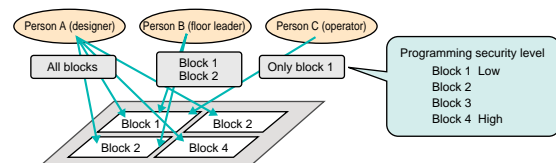

### ■ Reuse of programs is easy.

- Register time-proven programs by block in the library.
- By using variable identifiers (names), there is no need to be concerned with addresses for each machine when reusing programs.

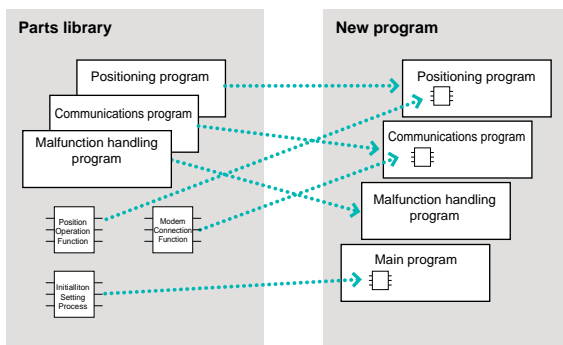

### ■ Operational Environment

OS	Windows95 (OSR2 or higher)/98/Me/NT (Ver. 4.0 or later)/2000/XP
Hard disk capacity	At least 100 MB
CPU	Pentium 100 MHz or higher
Onboard memory	At least 64 MB (depends on OS)
Screen resolution	At least 1024 × 768
Display colors	High Color (16-bit) or higher
Applicable PLC	FP-X*1/FP-e/FP0/FPΣ/FP1/FP-M/FP2/FP2SH/FP3/FP10SH

\*1: FP-X will be supported soon after Ver. 5.1.

# Part Number List

## FP-X Control Unit

Product name	Specifications	Part number
FP-X C14R Control unit	AC free power (110 to 240 V AC), 8-point input of 24 V DC, 6-point output of 2 A relay Program capacity 16 ksteps, 2-point potentiometer	AFPX-C14R
FP-X C30R Control unit	AC free power (110 to 240 V AC), 16-point input of 24 V DC, 14-point output of 2 A relay Program capacity 32 ksteps, 2-point potentiometer, USB port	AFPX-C30R
FP-X C60R Control unit	AC free power (110 to 240 V AC), 32-point input of 24 V DC, 28-point output of 2 A relay Program capacity 32 ksteps, 4-point potentiometer, USB port	AFPX-C60R

## FP-X Expansion Cassette

Product name	Specifications	Part number
FP-X COM1 Communication cassette	RS232C 1 ch. RS, CS control signal equipped (non-insulated)	AFPX-COM1
FP-X COM2 Communication cassette	RS232C 2 ch. (non-insulated)	AFPX-COM2
FP-X COM3 Communication cassette	RS485/422 selectable 1ch (insulated)	AFPX-COM3
FP-X COM4 Communication cassette	RS485 1 ch. (insulated) + RS232C 1 ch. (non-insulated)	AFPX-COM4
FP-X Input cassette	8 point input of 24 V DC	AFPX-IN8
FP-X Output cassette	8 point output of NPN 0.3 A	AFPX-TR8
FP-X Analog input cassette	2 point 12-bit non-insulated 0 to 10 V DC/0 to 20 mA	AFPX-AD2
FP-X Pulse I/O cassette	High-speed counter: single-phase 2 ch., each 100 kHz or two-phase 1 ch., 30 kHz. Pulse output: one axis 80 kHz/ch. (Use restriction is applied for a two-unit installation)	AFPX-PLS
FP-X Master memory with a real-time clock	Master memory: All 32 ksteps, all comments. Storage of FPWIN Pro source files. Real-time clock: Year, month, day, hour, minute, second, day of week (optional battery required)	AFPX-MRTC

## FP-X Expansion Unit

Product name	Specifications	Part number
FP-X E16R Expansion I/O unit	8-point input of 24 V DC, 6-point relay output of 2 A Remarks; Two or more E16R can't be connected serially because it can't supply the power to other units.	AFPX-E16R
FP-X E30R Expansion I/O unit	16-point input of 24 V DC, 14-point relay output of 2 A Remarks; Possible to connect up to 8 units including E16R, EFP0.	AFPX-E30R
FP0 expansion unit connection adapter	Up to 3 FP0 expansion units can be connected via an adapter.	AFPX-EFP0

## FP-X Options and Service Parts

Product name	Specifications	Part number
FP-X Backup battery	Battery for backing up the operation memory and real-time clock	AFPX-BATT
FP-X Expansion cable	Expansion unit connection cable, 8 cm	AFPX-EC08
FP-X Terminal block	Terminal block for C30R, C60R and E30R, 21 pins, cover with no marking, five units included	AFPX-TAN1

## FP0 Expansion Units

Product name	Specifications						Product number	Part number
	Number of I/O points	Power supply voltage	Input	Output	Connection type			
FP0 E8 Expansion Unit	8	Input: 8	–	24 V DC Sink/Source (±common)	–	MIL connector	FP0-E8X	AFP03003
	8	Input: 4 Output: 4	24 V DC	24 V DC Sink/Source (±common)	Relay output: 2 A	Terminal block	FP0-E8RS	AFP03023
	8	Output: 8	24 V DC	–	Relay output: 2 A	Molex connector	FP0-E8RM	AFP03013
	8	Output: 8	–	–	Relay output: 2 A Transistor output: NPN 0.1 A	Terminal block	FP0-E8YRS	AFP03020
FP0 E16 Expansion Unit	16	Input: 16	–	24 V DC Sink/Source (±common)	–	MIL connector	FP0-E16X	FP03303
	16	Input: 8 Output: 8	24 V DC	24 V DC Sink/Source (±common)	Relay output: 2 A	Terminal block	FP0-E16RS	AFP03323
	16	Input: 8 Output: 8	–	24 V DC Sink/Source (±common)	Relay output: 2 A Transistor output: NPN 0.1 A	Molex connector	FP0-E16RM	AFP03313
	16	Output: 16	–	–	Transistor output: NPN 0.1 A	MIL connector	FP0-E16T	FP03343
FP0 E32 Expansion Unit	32	Input: 16 Output: 16	–	24 V DC Sink/Source (±common)	Transistor output: NPN 0.1 A	MIL connector	FP0-E32T	FP03543

- Notes: 1) The relay output type expansion units come with a power cable (part number AFP0581). (The transistor output type needs no power cable.)  
 2) The terminal block type relay output units have 2 terminal blocks (9 pins) made by Phoenix. Use a 2.5 mm wide screwdriver.  
 Preferably use the specific terminal block screwdriver (part number AFP0806, Phoenix type code SZS 0.4 × 2.5 mm) or equivalent.  
 3) The connector-type relay output units have 2 connectors made by Nihon Molex (Molex type code 51067-0900, 9 pins).  
 Use the specific Molex connector press-fit tool (part number AFP0805, Nihon Molex type code 57189-5000) or equivalent.  
 4) The transistor output units have a press-fit socket for wire-pressed terminal cable and contacts. Use the press-fit tool (part number AXY52000) for wire-pressed terminal cable.

## FP0 Intelligent Units

Product name	Specifications	Product number	Part number
FP0 Thermocouple unit	K, J, T, R thermocouple, Resolution: 0.1 °C	FP0-TC4	AFP0420
	K, J, T, R thermocouple, Resolution: 0.1 °C	FP0-TC8	AFP0421
FP0 Analog I/O unit	<Input specifications> Number or channels: 2 channels Input range: 0 to 5 V, -10 to +10 V (Resolution: 1/4000) 0 to 20 mA (Resolution: 1/4000)	FP0 - A21	AFP0480
	<Output specifications> Number or channels: 1 channel Output range: -10 to +10 V (Resolution: 1/4000) 0 to 20 mA (Resolution: 1/4000)		
FP0 A/D Converter Unit	<Input specifications> Number or channels: 8 channels Input range: 0 to 5, -10 to +10 V (Resolution: 1/4000) 0 to 20 mA (Resolution: 1/4000)	FP0-A80	AFP0401
FP0 D/A Converter Unit	<Output specifications> Number or channels: 4 channels Output range: -10 to +10 V (Resolution: 1/4000) 4 to 20 mA (Resolution: 1/4000)	FP0-A04V	AFP04121
		FP0-A04I	AFP04123

## FP0 Link Units

Product name	Specifications	Power supply voltage	Product number	Part number
FP0 CC-Link Slave unit	This unit is for making the FP0 function as a slave station of the CC-Link. Only one unit can be connected to the furthest right edge of the FP0 expansion bus. Note: Accuracy will change if an FP0 thermocouple unit is used at the same time. For details, please refer to the catalog or to the CC-Link Unit manual.	24 V DC	FP0-CCLS	AFP07943
FP0 I/O Link unit	This is a link unit designed to make the FP0 function as a station to MEWNET-F (remote I/O system).	24 V DC	FP0-IOL	AFP0732

# Part Number List

## FP0 European Products

Product name	Specification	Part number
FP0 Expansion Unit	DC input 16, Relay(2A) output 16, Screw terminal Block	FP0-E32RS
FP0 RTD Unit	RTD (Pt100, Pt1000, Ni1000) input 6ch	FP0-RTD6
FP0 PROFIBUS Unit	DP slave, Remote I/O (up to 3 FP0 expansion units)	FP0-DPS2

Note) These products are provided from Panasonic Electric Works Europe AG

## Control FPWIN GR for Windows

Product name	Type		Part number	Applicable PLC									
				FP-X	FP	FP0 FP-e	FP0 10k	FP1	FP2	FP2SH	FP-M	FP3 FP10SH	
FPWIN GR for Windows	English: Full type	CD-ROM for Windows	AFPS10520	A	A	A	A	A	A	A	A	A	A
	English: Small type	CD-ROM for Windows	AFPS11520	A	A	A	A	A	N/A	N/A	A	N/A	
	English: Ver. up type	CD-ROM for Windows	AFPS10520R	A	A	A	A	A	A	A	A	A	A
	Chinese	CD-ROM for Windows	AFPS10820										
	Chinese: Ver. up type	CD-ROM for Windows	AFPS10820R										
Korean	CD-ROM for Windows	AFPS10920											

A: Available, N/A: Not available

## Control FPWIN Pro (IEC61131-3 compliant Windows version software)

Product name	Type		Part number	Applicable PLC									
				FP-X	FP	FP0 FP-e	FP0 10k	FP1	FP2	FP2SH	FP-M	FP3 FP10SH	
FPWIN Pro for Windows	English: Full type	CD-ROM for Windows	AFPS50550	A	A	A	A	A	A	A	A	A	A
	English: Small type	CD-ROM for Windows	AFPS51550	A	A	A	A	A	N/A	N/A	A	N/A	

A: Available, N/A: Not available

## Programmable Display GT series

Product name	Description			Part number	
GT01: Main Unit	STN monochrome LCD	5 V DC	RS232C type	Black	AIGT0030B1
				Ash gry	AIGT0030H1
			Black	AIGT0032B1	
		24 V DC	RS422/RS485 type	Ash gry	AIGT0032H1
				Black	AIGT0030B
			Black	AIGT0030H	
GT11: Main Unit	STN monochrome LCD	24 V DC	RS232C type	Black	AIGT0032B
				Ash gry	AIGT0032H
			Black	AIGT2030B	
		RS422/RS485 type	Ash gry	AIGT2030H	
			Black	AIGT2032B	
			Ash gry	AIGT2032H	
GT30: Main Unit	STN monochrome LCD	24 V DC	RS232C type	Black	AIGT3100B
				Ash gry	AIGT3100H
			Black	AIGT3300B	
	STN color LCD		RS232C type	Ash gry	AIGT3300H
				Black	AIGT3300B
			Ash gry	AIGT3300H	

## FP Memory Loader

Product name	Part number
Data non-hold type	AFP8670
Data hold type	AFP8671

## MEWTOCOL OPC Server

Product name	Part number
Standard version	AFPS01510
5 license version	AFPS01515
10 license version	AFPS01516

## PCWAY Ver. 2.6 (Operation Data Managing Software)

Product name	Part number
PCWAY IBM printer port version	AFW10011
PCWAY USB port version	AFW10031
PCWAY Version upgrade	AFW10401

\* Charged version upgrade for Ver. 2.0 to 2.4.

## FP Web-Server Unit

Product name	Part number
FP Web-Server unit	AFP0610
FP Web Configurator Tool	AFPS30510

## Control CommX Ver. 1.2 (OCX for Communication)

Product name	Part number
Control CommX IBM printer port	AFW20011
Control CommX USB port	AFW20031

## FP Web Configurator Tool

Product name	Part number
FP Web Configurator Tool	AFPS30510

## Key Unit

Economical type is available for secondary key.  
The key unit is available for PCWAY and Control CommX.

Product name	Part number
Key unit IBM printer port version	AFW1031
Key unit USB port version	AFW1033

# Specifications

## 1. General Specifications

Item	Description
Rated voltage	100 to 240 V AC
Operating voltage range	85 to 264 V AC
Rush current	40 A or less (C14R), 45 A or less (C30R, C60R) at 25°C
Allowed momentary power off time	10 ms or more
Ambient temperature	0 to +55°C
Storage temperature	-40 to +70°C
Ambient humidity	10 to 95% RH (at 25 °C, non-condensing)
Storage humidity	10 to 95% RH (at 25 °C, non-condensing)
Breakdown voltage	Combined input/output terminals - Combined power and ground terminals, 2300 V AC 1 minute
	Input terminals - Relay output terminals, 2300 V AC* 1 minute
	Power terminals - Ground terminals, 1500 V AC* 1 minute
	*Cutoff current 5 mA
The same value applies between the terminals above and the input/output terminals of an expansion cassette.	
Insulation resistance	Combined input/output terminals - Combined power and ground terminals, 100 MΩ or higher (500 V DC using an insulation resistance meter)
	Input terminals - Output terminals, 100 MΩ or higher (500 V DC using an insulation resistance meter)
	Power terminals - Ground terminals, 100 MΩ or higher (500 V DC using an insulation resistance meter)
	The same value applies between the terminals above and the input/output terminals of an expansion cassette.
Vibration resistance	5 to 9 Hz, single amplitude 3.5 mm/9 to 150 Hz, constant acceleration 9.8 m/s <sup>2</sup> , 1 sweep/min, 10 sweeps in each XYZ direction
Shock resistance	147 m/s <sup>2</sup> , sinusoidal half wave pulse
Noise immunity	1500 V [P-P] pulse width 50 ns, 1 μs (per noise simulator method) (power terminals)
Operating condition	No corrosive gas and no excessive dust
Applicable standards	Conforming to EN61131-2
Level of contamination	2
Over-voltage category	II

## 2. Power Consumption, Weight

Product name	Part number	Current consumption	Weight
Control unit	AFPX-C14R	26 W or less <sup>*1</sup>	Approx. 280 g
	AFPX-C30R	52 W or less <sup>*1</sup>	Approx. 490 g
	AFPX-C60R	64 W or less <sup>*1</sup>	Approx. 780 g
Expansion I/O unit	AFPX-E16R	8 W or less <sup>*1</sup>	Approx. 195 g
Expansion FP0 adapter	AFPX-EFP0	0.24 W or less <sup>*2</sup>	Approx. 65 g
FP-X communication cassette	AFPX-COM1	2 W or less <sup>*1</sup>	Approx. 20 g
	AFPX-COM2	2 W or less <sup>*1</sup>	Approx. 20 g
	AFPX-COM3	2 W or less <sup>*1</sup>	Approx. 20 g
	AFPX-COM4	2 W or less <sup>*1</sup>	Approx. 20 g
FP-X analog input cassette	AFPX-AD2	2 W or less <sup>*1</sup>	Approx. 25 g
FP-X input cassette	AFPX-IN8	1 W or less <sup>*1</sup>	Approx. 25 g
FP-X output cassette	AFPX-TR8	1 W or less <sup>*1</sup>	Approx. 25 g
FP-X pulse I/O cassette	AFPX-PLS	2 W or less <sup>*1</sup>	Approx. 25 g
FP-X master memory cassette	AFPX-MRTC	2 W or less <sup>*1</sup>	Approx. 20 g

\*1 Power consumption by the AC power supply connected to the control unit

\*2 Power consumption by the DC power supply connected to the expansion FP0 adapter

# Specifications

## 3. Controls Specifications

Item	Specifications
Program method	Relay symbol method
Control method	Cyclic operation method
Program memory	Flash ROM built-in (no battery backup required)
Program capacity	16 ksteps (C14R), 32 ksteps (C30R, C60R)
Operation processing speed	Basic instruction 0.32 μs/step
Basic instructions	93
Applied instructions	216
External inputs (X)	1760 points *1
External outputs (Y)	1760 points *1
Internal relay (R)	4096 points
Special internal relay (R)	192 points
Link relay (L)	2048 points
Timer/counter (T/C)	Total 1024 points: timer capable of counting (1 ms, 10 ms, 100 ms, 1 s) x 32767 Counter capable of counting 1 to 32767
Data register (DT)	12285 words (C14R), 32765 words (C30R, C60R)
Link data register (LD)	256 words
Special data register (DT)	374 words
Index register (I0 to ID)	14 words
Master control relay (MCR)	256 points
Number of labels (LOOP)	256 labels
Number of differentiations	Up to program capacity
Number of stepladders	1000 stages
Number of subroutines	500 subroutines
Number of interruption programs	15 programs (14 external, 1 constant)
High-speed counter *2	Control unit built-in timer: single-phase 8 ch (10 kHz), or two-phase 4 ch (5 kHz) Pulse I/O cassette (AFPX-PLS): single-phase 2 ch (80 kHz), or dual-phase 1 ch (30 kHz)
Pulse output *3	Pulse I/O cassette (AFPX-PLS): One unit (one axis) 100 kHz, or two units (two axes) 80 kHz
Pulse catch input / interrupt input	Total 14 points (including the high-speed counter)
Periodical interrupt	0.5 ms to 30 s
Potentiometer	2 points (0 to 1000) (C14R, C30R) 4 points (0 to 1000) (C60R)
Constant scan	Possible
Real-time clock	Equipped (usable only when AFPX-MRTC is installed) *4
Flash ROM backup *6	Backup by F12, P13 commands
	Auto-backup at power failure
Battery backup	The memory allocated in the storage area by the system register (only when a battery is installed) *5
Battery life (when no power is supplied)	Before installing AFPX-MRTC C14R: 1230 days (actual operation 10 years at 25°C) C30R,C60R: 990 days (actual operation 10 years at 25°C) After installing AFPX-MRTC C14R: 780 days (actual operation 10 years at 25°C) C30R, C60R: 680 days (actual operation 10 years at 25°C) (More than two batteries can be installed in C30R and C60R. In this case, the battery life is extended several times)
Password	Capable (4 or 8 characters selectable)
Self-diagnosis function	Watch dog timer, program syntax check
Comment storage	Capable (328 KB) (backup battery not required)
PLC link function	Max 16 units, link relay 1024 points, link register 128 words (No data transfer or remote programming)
Rewriting in RUN mode	Capable

\*1 The actual usable number of points is restricted by the hardware.

\*2 Specification at the rated input voltage of 24 V DC, 25°C. Frequency may be lower due to the voltage and temperature.

\*3 Max frequency may vary by the method of operation. Please refer to the manual for details.

\*4 Calendar accuracy at 0°C: 119 sec/month or less, 25°C: 51 sec/month or less, 55°C: 148 sec/month or less (Real-time clock requires a battery.)

\*5 When data is stored in the storage area while the battery is not installed, the data is not cleared and the data value may be insignificant.

The same condition occurs when the battery is exhausted.

\*6 The number of possible rewrites is 10,000 or less.

#### 4. Input Specifications (Control unit, expansion unit)

Item		Description
Insulation method		Photo-coupler
Rated input voltage		24 V DC
Operating voltage range		21.6 to 26.4 V DC
Rated input current		Approx. 4.7 mA (Control unit X0 to X7) Approx. 4.3 mA (Control unit X8 and after, expansion unit)
Input points per common		8 points/common (C14, E16) 16 points/common (C30, E60) (Input power polarity either positive or negative)
Min. ON voltage/ON current		19.2 V/3 mA
Max. OFF voltage/OFF current		2.4 V/1 mA
Input impedance		Approx. 5.1 k $\Omega$ (Control unit X0 to X7) Approx. 5.6 k $\Omega$ (Control unit X8 and after, expansion unit)
Response time	OFF $\rightarrow$ ON	Control unit X0 to X7 0.6 ms or less: Normal input 50 $\mu$ s or less: High-speed counter, pulse catch, interruption input setting *7 Control unit X8 and after, expansion unit 0.6 ms or less
	ON $\rightarrow$ OFF	Same as above
Operating indicator		LED display

\*7 Specification at the rated input voltage of 24 V DC, 25°C.

#### 5. Relay Output Specifications (Control units, Expansion units)

Item		Description
Output type		1a contact
Rated control capacity (Resistive load)		2 A 250 V AC, 2 A 30 V DC (8 A or less/common)
Output points per common		8 points/common
Response time	OFF $\rightarrow$ ON	Approx. 10 ms
	ON $\rightarrow$ OFF	Approx. 8 ms
Life time	Mechanical	20 million operations or more (Operation frequency 180 times/min)
	Electrical	100,000 operations or more (Operation frequency 20 times/min at the rated control capacity)
Surge absorber		None
Operating indicator		LED display

#### Internal circuit

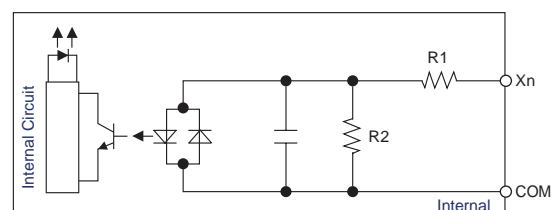

X0 to X7 : R1=5.1 k $\Omega$  R2=3 k $\Omega$   
 X8 and after : R1=5.6 k $\Omega$  R2=1 k $\Omega$   
 R1=6.8 k $\Omega$  R2=820 $\Omega$

#### Internal circuit

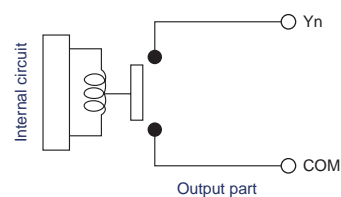

## ■ FP-X Control Unit Dimensions (Unit: mm)

●AFPX-C14R (The same dimensions apply to the expansion I/O unit AFPX-E16R)

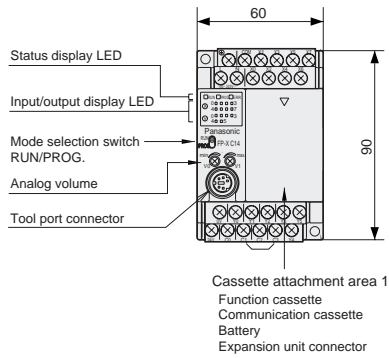

Dimensions when expansion cassettes (function and communication) are installed

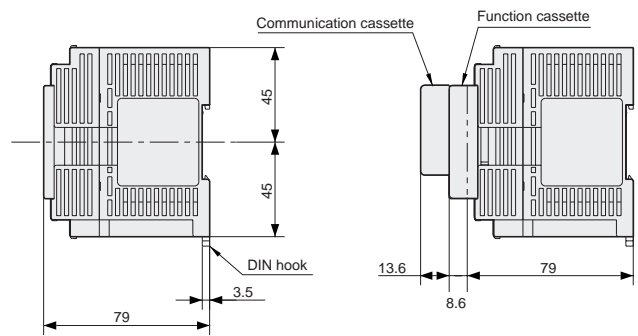

●AFPX-C30R

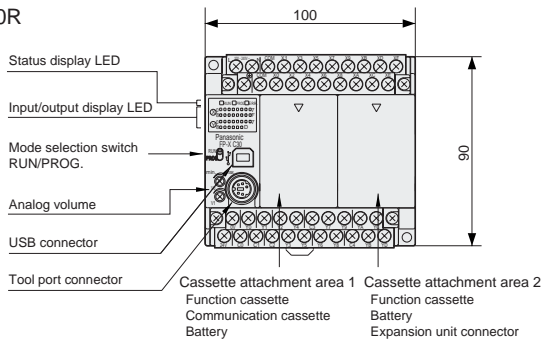

Mounting dimension diagram

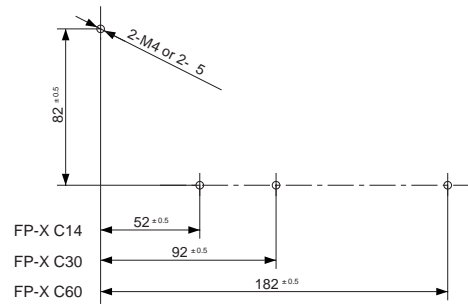

●AFPX-C60R

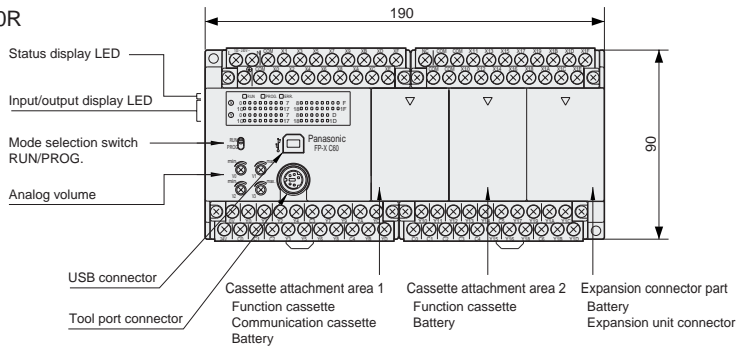

## ■ FP-X Expansion FP0 Adapter Dimensions (Unit: mm)

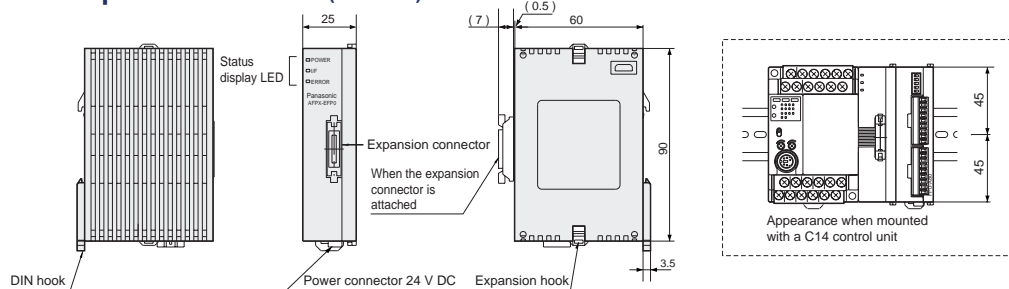

These materials are printed on ECF pulp.  
These materials are printed with earth-friendly vegetable-based (soybean oil) ink.



Please contact .....

# Matsushita Electric Works, Ltd.

Automation Controls Business Unit

■ Head Office: 1048, Kadoma, Kadoma-shi, Osaka 571-8686, Japan

■ Telephone: +81-6-6908-1050 ■ Facsimile: +81-6-6908-5781

<http://www.nais-e.com/>

# Panasonic®

All Rights Reserved © 2005 COPYRIGHT Matsushita Electric Works, Ltd.